

Internet Camera

ICA-101/ICA-101W

User's Manual



Copyright

Copyright (C) 2003 PLANET Technology Corp. All rights reserved.

The products and programs described in this User's Manual are licensed products of PLANET Technology. This User's Manual contains proprietary information protected by copyright, and this User's Manual and all accompanying hardware, software, and documentation are copyrighted.

No part of this User's Manual may be copied, photocopied, reproduced, translated, or reduced to any electronic medium or machine-readable form by any means by electronic or mechanical. Including photocopying, recording, or information storage and retrieval systems, for any purpose other than the purchaser's personal use, and without the prior express written permission of PLANET Technology.

Disclaimer

PLANET Technology does not warrant that the hardware will work properly in all environments and applications, and makes no warranty and representation, either implied or expressed, with respect to the quality, performance, merchantability, or fitness for a particular purpose.

PLANET has made every effort to ensure that this User's Manual is accurate; PLANET disclaims liability for any inaccuracies or omissions that may have occurred.

Information in this User's Manual is subject to change without notice and does not represent a commitment on the part of PLANET. PLANET assumes no responsibility for any inaccuracies that may be contained in this User's Manual. PLANET makes no commitment to update or keep current the information in this User's Manual, and reserves the right to make improvements to this User's Manual and/or to the products described in this User's Manual, at any time without notice.

If you find information in this manual that is incorrect, misleading, or incomplete, we would appreciate your comments and suggestions.

CE mark Warning

The is a class B device, In a domestic environment, this product may cause radio interference, in which case the user may be required to take adequate measures.

Trademarks

The PLANET logo is a trademark of PLANET Technology. This documentation may refer to numerous hardware and software products by their trade names. In most, if not all cases, these designations are claimed as trademarks or registered trademarks by their respective companies.

Revision

User's Manual for PLANET Internet Camera:

Model: ICA-101/ICA-101W

Rev: 1.0 (May 2003)

Part No. EM-ICA101

TABLE OF CONTENTS

CHAPTER 1 INTRODUCTION	1
ICA-101/ICA-101W Features	1
Package Contents	2
Physical Details	2
CHAPTER 2 INSTALLATION	5
Requirements	5
Connecting ICA-101 series to the Camera Stand.....	5
Hardware Install Procedure.....	6
CHAPTER 3 INITIAL SETUP	7
Preparation	7
Procedures	7
CHAPTER 4 WEB USER INTERFACE	12
Introduction	12
Login	12
View Video	12
Administration	15
CHAPTER 5 CLIENT UTILITY	26
Install Procedure	26
Using Viewer & Recorder Utility	28
APPENDIX A FREQUENTLY ASKED QUESTIONS	33
APPENDIX B TROUBLE SHOOTING.....	34
APPENDIX C SPECIFICATION.....	36

Chapter 1

Introduction



As broadband communication gets more and more popular, transferring video and audio through networks has become a major issue. The ICA-101 family provides an advanced Internet Camera solution, supporting wired or wireless Ethernet networking. The ICA-101/ICA-101W can be placed wherever there is a wired/wireless LAN or an available xDSL/Cable modem connection, and the ICA-101 family also supports DDNS. Even when your gateway does not support DDNS, it can still co-operate with the ICA-101 family and provide live images to Internet users.

The ICA-101 family uses advanced MPEG-4 video compression technology. An advanced microcomputer is integrated into this camera to digitize live video, and then compress the video stream using MPEG-4. The high compression capabilities of MPEG-4 reduce network bandwidth requirements to amazingly low levels. With their Plug-N-Watch capability, a network administrator or system operator can seamlessly complete network deployment in just minutes!

ICA-101/ICA-101W Features

Simple to use

Plug-N-Watch capability to simplify system integration in an existing network environment

Suitable for home, business, or public facilities

The ICA-101 family can be deployed in many different situations and reduce the cost of human resources, offering flexibility, affordability, and reliability for surveillance of manufacturing and other facilities.

Remote Monitoring and Management.

ICA-101 series can fully integrate with your network. By the conveniences of world wide Internet, you can do the monitoring anywhere. Via add-on utility, network administrators can decide whether individuals or the whole team may access ICA-101 series. Multi-user password protection support offers more flexibility while managing ICA-101 series.

Multiple platform support

Supports TCP/IP networking, SMTP e-mail, HTTP, PPPoE and other Internet related protocols. The ICA-101 family can be applied and utilized in a mixed operating system network environment.

Easy configuration

The network administrator can configure and manage ICA-101 family via Windows-based utility or web interface.

Bundled recording utility

Provides the convenience to schedule your recording plan.

Motion detection

Monitoring any suspicious movement in specific area.

DDNS support

In order to view video over Internet, the user must know the Internet IP address of the gateway used by the camera. If the gateway has a dynamic IP address, DDNS (Dynamic DNS) is required. Since many gateways do not support DDNS, this function is incorporated into ICA-101 family.

Audio support

With an external microphone attached, audio can be recorded with live images.

Package Contents

The following items should be included:

- Internet Camera unit
- Camera Stand Accessory
- Power Adapter
- CD-ROM
- Quick Installation Guide

If any of the above items are damaged or missing, please contact your dealer immediately.

Physical Details

Front Panel

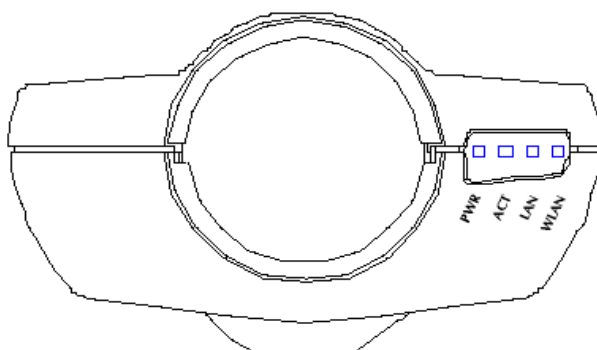

Front Panel of ICA-101W

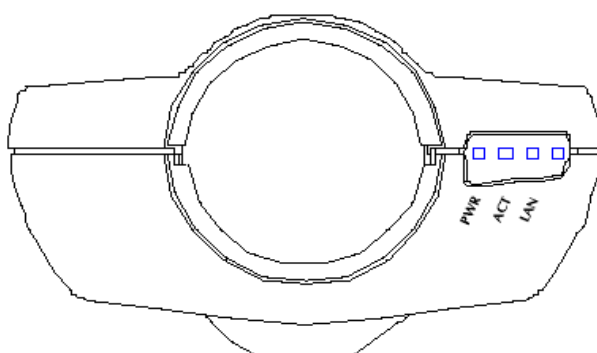

Front Panel of ICA-101

LED definition:

PWR	On - Internet Camera is powered on.
ACT	Blink - Internet Camera is active.
LAN	On – LAN port is active. Blink – Data is transferring via LAN port.
WLAN	On – Wireless interface is active. Blink – Data is transferring via wireless interface.

Rear Panel

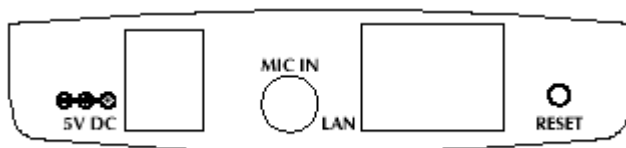

Button definition

Reset Button	<p>This button has two (2) functions:</p> <ul style="list-style-type: none">• When pressed and released, Internet Camera will reset (restart).• When reset button is pressed over 3 seconds and then release. ALL data will be clear and restore ALL settings to the factory default values.
--------------	---

Chapter 2

Installation

2

Requirements

	<i>ICA-101</i>	<i>ICA-101W</i>
Network Environment		
LAN	10/ 100M Ethernet	10/ 100M Ethernet IEEE 802.11b Wireless LAN
Monitoring System Recommended		
System Hardware	<ul style="list-style-type: none">• CPU: Pentium II, 266 MHz or above• Memory Size: 32 MB (64 MB recommended)• VGA card resolution: 800x600 or above	
System Requirement for Viewer & Recorder Application		
Support OS	Win 98 SE, Win 2000, Win Me, Win XP	
System Hardware	<ul style="list-style-type: none">• CPU: Pentium III, 450 MHz or above• Memory Size: 128 MB (256 MB recommended)• VGA card resolution: 800x600 or above	

Connecting ICA-101 series to the Camera Stand

ICA-101 series comes with a camera stand accessory with a swivel ball screw head that can be attached to ICA-101 series' bottom screw hole. Attach the camera stand to ICA-101 series and station it for your application. There are three holes located in the base of the camera stand allowing ICA-101 series to be mounted on the ceiling or any wall securely.

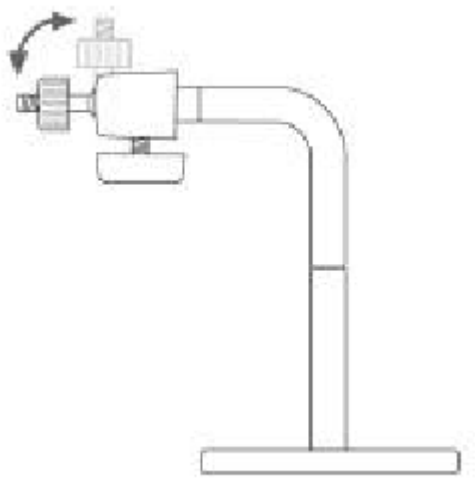

Hardware Install Procedure

1. Connect an Ethernet cable

Connect one end of an Ethernet cable to the LAN port located on the ICA-101/101W rear panel and attach the other end to the network device (hub or switch). If you want to use wireless connection for ICA-101W, you can skip this step.

2. Attach the external power supply

Connect the provided power adapter to the ICA-101's connector labeled "5VDC" on rear panel.

3. Check the LEDs

The PWR would flash for few seconds to detect network connection. The network indication LEDs (LAN or WLAN) would be on depending on which network type is available.

Chapter 3

Initial Setup

3

Preparation

The initial setup of ICA-101 series must be done through bundled Setup Wizard utility. Before starting installation, please ensure that:

- Your PC can establish a physical connection to the Internet Camera. The PC and the Internet Camera must be directly connected (using the LAN port on the Internet Camera) or on the same LAN segment. That is, the PC must be configured to an IP address and subnet mask in 192.168.0.x segment. For example: IP: 192.168.0.2, subnet mask: 255.255.255.0.
- The Internet Camera must be installed and powered ON.
- If the Internet Camera's default IP Address (192.168.0.20) is already used by another device, the other device must be turned OFF until the Internet Camera is allocated a new IP Address during configuration.

Procedures

1. Insert the CD-ROM into the CD-ROM drive to initiate the autorun program. Once completed, a menu screen would appear as follow.

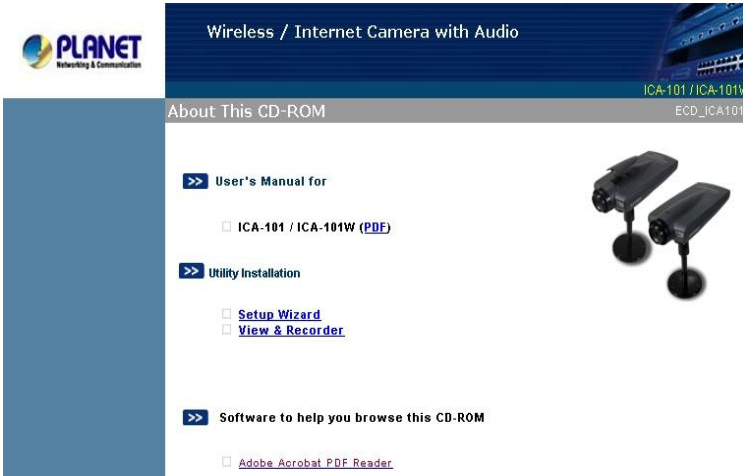

2. Click on **Setup Wizard** hyperlink to activate the initial setup.
If the above screen is not shown, you can start the installation as follows.
 - Click on **Start Menu/ Run**.
 - Enter "D:\Utility\wizard.exe" in the appeared box, where "D" is the letter of your CD-ROM drive.
 - Click on "OK" button.
3. Once the wizard is activated, it would search available camera automatically.

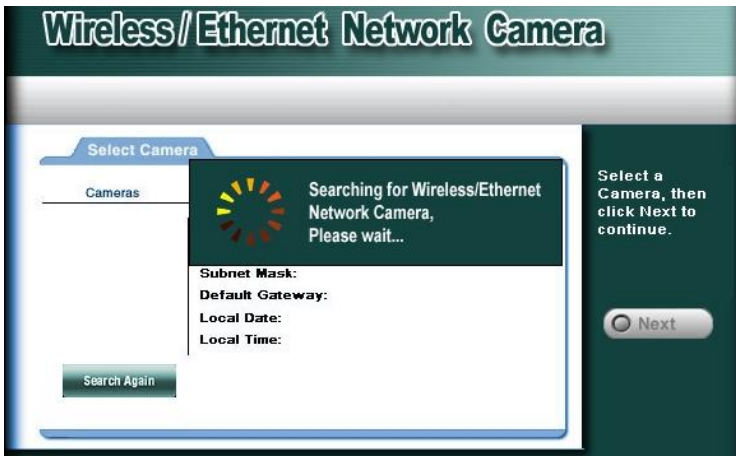

4. The screen will list all cameras in your LAN. You can view their current settings by selecting respective Device Name from left panel. Choose the one you want to configure, click **Next**.



5. A password verification screen will pop up. Please key in administrator name and password for login. The default strings are admin/admin.

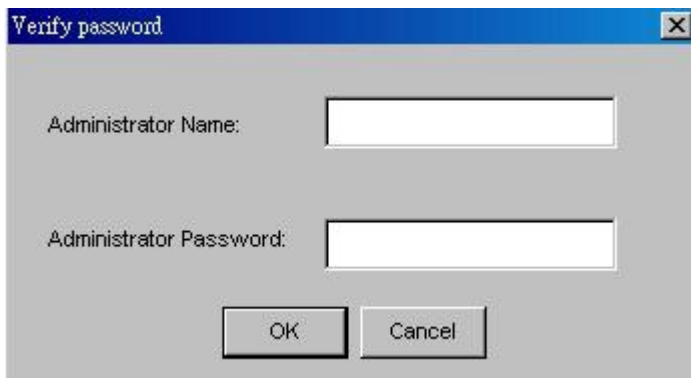

6. In the next screen, you can select “**Fixed IP Address**” or “**Dynamic IP Address**”. **Fixed IP Address** is recommended, and can always be used. **Dynamic IP Address** can only be used if your LAN has a DHCP Server. If you select “**Dynamic IP Address**”, please go to step 8.

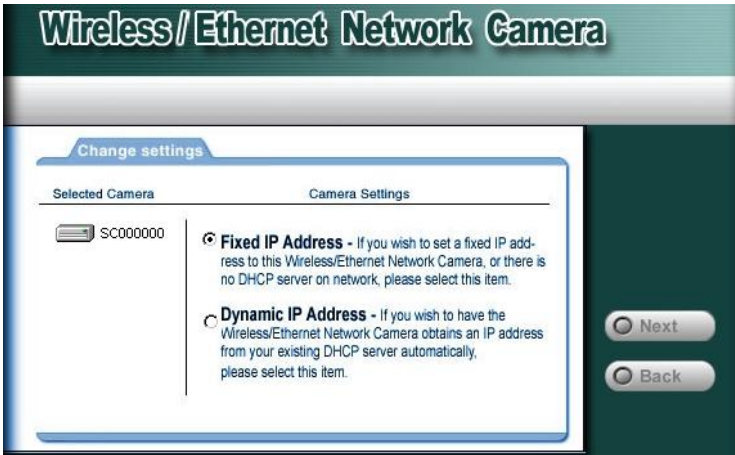

7. Enter the desired network settings: **IP Address**, **Subnet Mask**, and **Default Gateway**. Click **“Next”** to proceed.

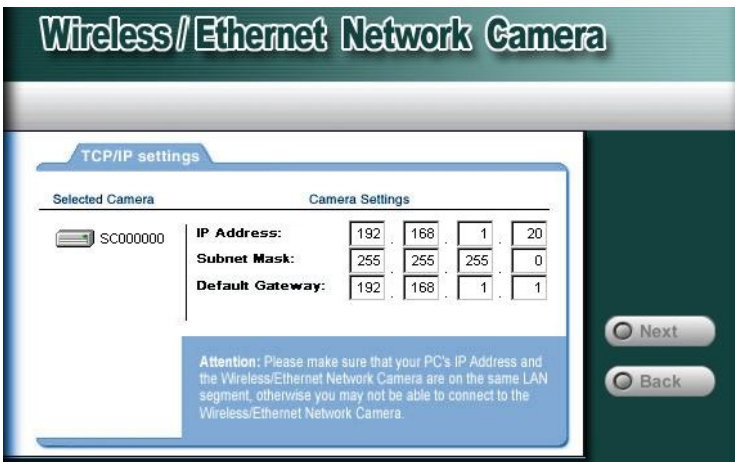

8. If you are using ICA-101, please skip to step 10. This screen allows you to configure wireless settings: **Mode**, **Authentication Type**, **ESSID**, **Domain**, and **Channel**. Enter appropriate values in each field, then click **“Next”**.

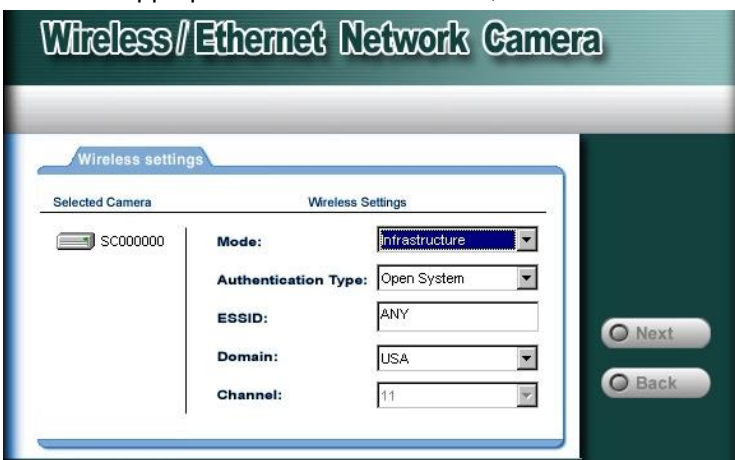

9. WEP key settings are used to secure your wireless connection. Enter the suitable settings in each field, then click **“Next”**.

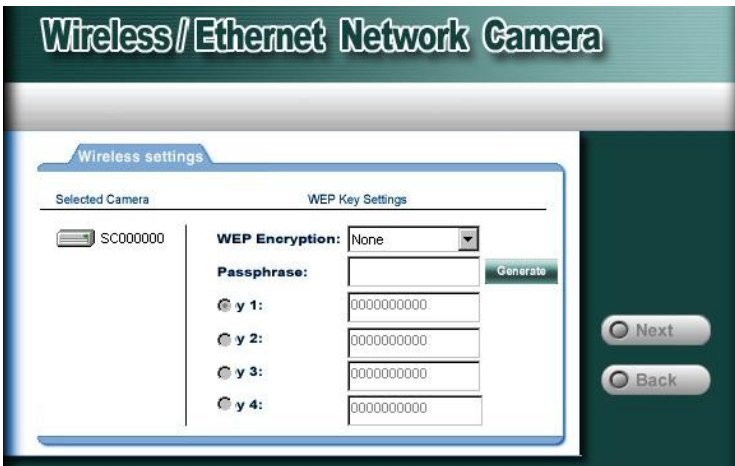

10. The next screen allows you to enter a suitable **Description**, and set the correct **Date**, **Time**, and **Time Zone**. Make any desired changes, then click **Next** to continue.

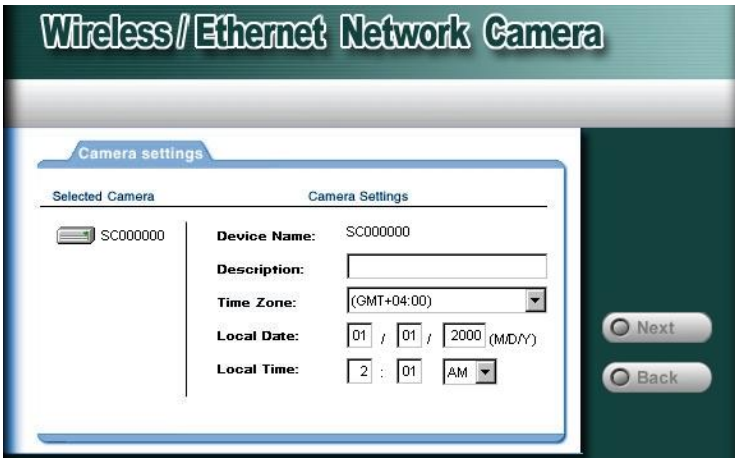

11. The Save settings screen displays all the details of your camera. Click **“Save”** if all settings are correct, or click **“Back”** to modify incorrect values.

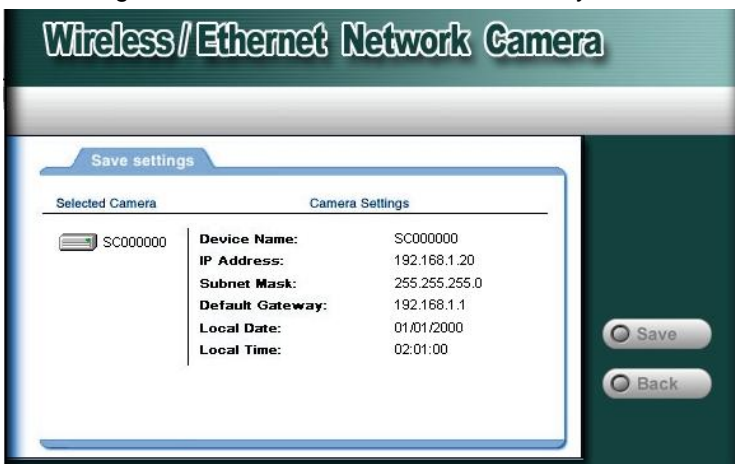

12. After saving all settings, the follow screen appears. You can click the **“Web UI”** to connect to the camera using your Web Browser, or click **“Exit”** to close Setup Wizard.



13. Click on **“Web UI”** to access the web interface of ICA-101 series. Please refer to chapter 4 for more information about web UI. Click on **“Exit”** to close Setup Wizard.

Chapter 4

Web User Interface

4

Introduction

After finishing the initial setup of ICA-101 series, your camera is ready to use for all users in LAN. This chapter describes how to view live image and manage camera with web browser. The demonstration screens are from ICA-101W, the screens of ICA-101 are similar except some wireless settings.

Login

Activate the web browser, type “http://192.168.0.20” in the address box to access Welcome page of ICA-101 series. The lower right of the page shows information of Device Name, Description, and IP Address.

The screenshot shows the web interface for a Planet Wireless Internet Camera. At the top left is the Planet logo. The main header reads "Wireless Internet Camera" in yellow text. Below the header is a navigation bar with links: "Home | View Video | Administration | Exit". The central area features a "Welcome" message and a large graphic of a camera lens surrounded by several small video thumbnails. In the bottom right corner, the following device information is displayed:

Device Name:	SC000000
Description:	PLANET
IP Address:	192.168.0.20

There are four options which are available for all screens:

- **Home:** return to Welcome page.
- **View Video:** view live images.
- **Administration:** access the management screens.
- **Exit:** close the current screen and terminate the connection to camera.

View Video

You can view live video via web browser by selecting “**View Video**” option. Please note that this option needs to download and install an ActiveX control “NetCamPlayer-web.ocx” to your computer. Please change the security settings of your browser with following procedures first.

1. Click “Tools” from upper tool bar of browser, select “Internet Options...”.

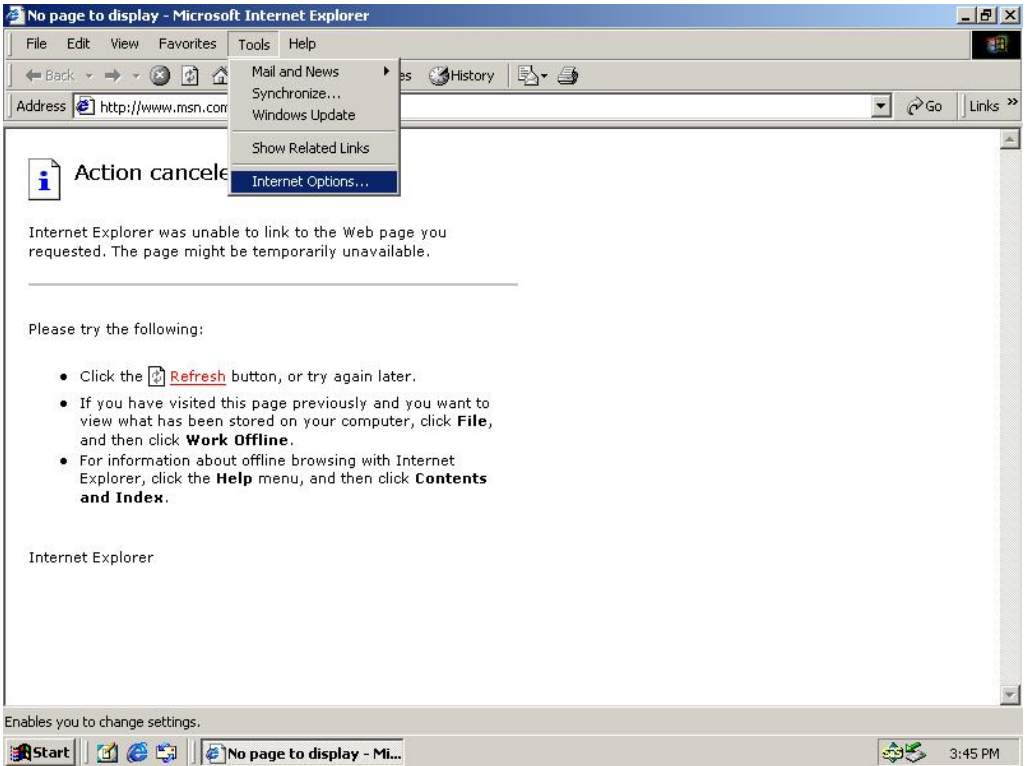

2. Select "Security" tab, choose "Internet" zone. Click "Custom Level..." button.

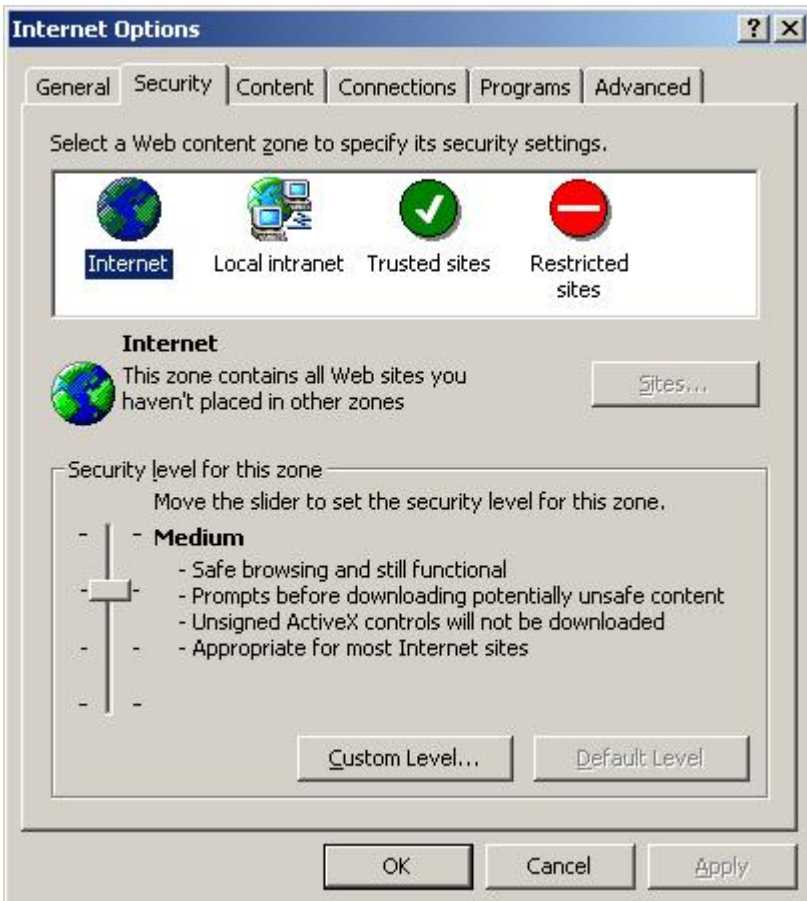

- Find the settings of “Download unsigned ActiveX controls”, change the option to “Prompt”.

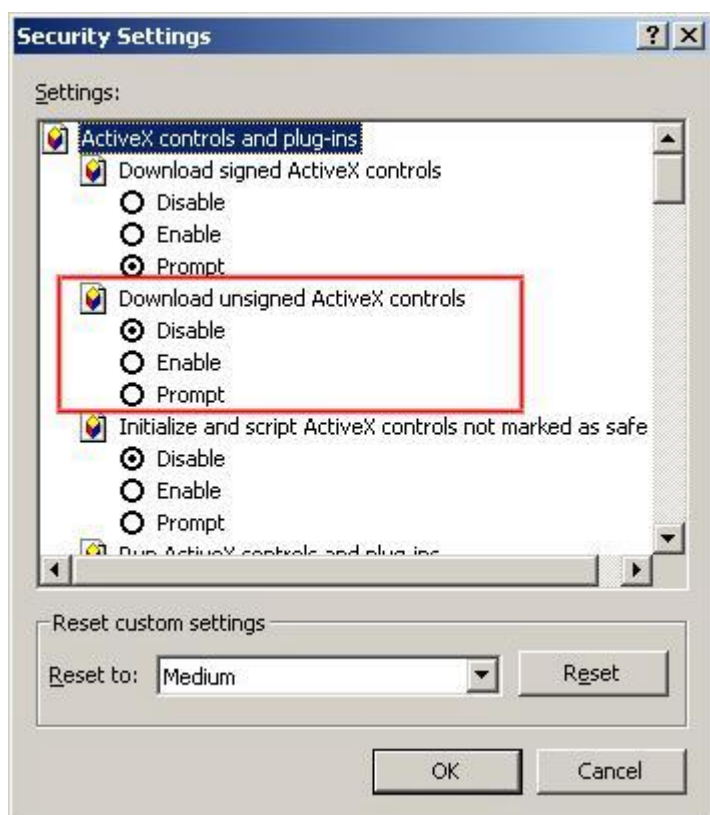

- Click “OK” button.
- Click “Yes” while Warning dialog box appears.



- Click “Apply”, then “OK” button to finish the setting.

After the setting is done, a “Security Warning” dialog box would appear while you select “View Video”. Ensure the path and the ocx file name is correct, then click “Yes” to continue.



Once the installation is successfully finished, you will see the live video immediately.



Administration

Once you click "Administration" option, a dialog box will pop up. Please enter default username/password as admin/admin to access the management screens.



The management screens contain 5 sub-screens: System, Network, Image, User, and Status.

System

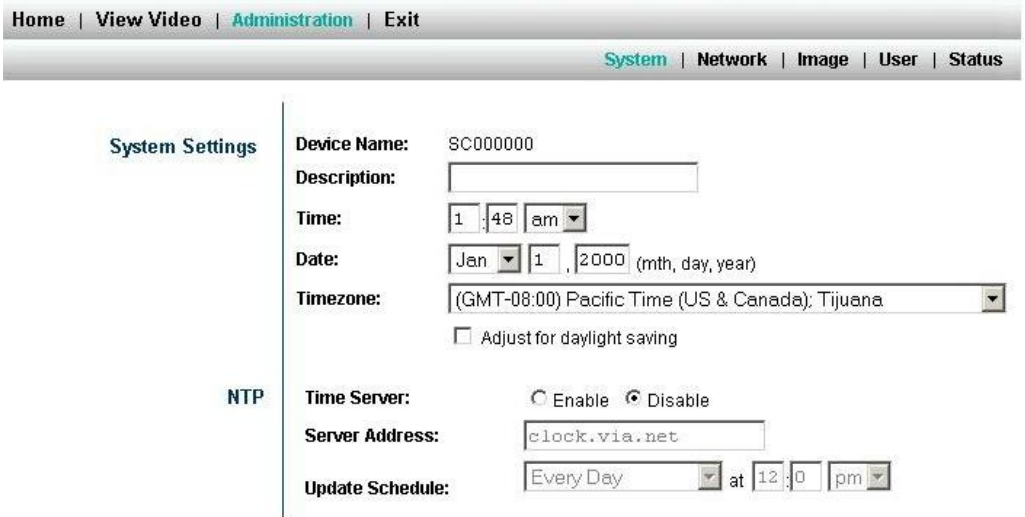

System Settings:

Device Name:

This field displays the name of your ICA-101 series. It cannot be changed.

Description:

This field is used for entering a descriptive name for the location used by ICA-101 series.

Time:

Enter the current time.

Date:

Enter the current date.

Timezone:

Select the time zone where you are locating from the drop-down list. If you are in a daylight saving area, check the box in front of “Adjust for daylight saving”.

NTP:

Time Server:

Enable or disable the Time Server feature as required. If enabled, ICA-101 series will contact a Network Time Server at regular intervals and update its internal time.

Server Address:

Enter the Address of the Time Server in this field.

M Note	Please find below NTP server web address for your reference to set the time server. http://www.eecis.udel.edu/~mills/ntp/clock1.htm http://www.eecis.udel.edu/~mills/ntp/clock2.htm
-------------------------	---

Update Schedule:

This option determines how often ICA-101 series synchronizes its time with time server.

Apply/Cancel:

After making sure all settings in the System are correct, click on the “**Apply**” icon to store the settings for ICA-101 series. You can alternatively click on the “**Cancel**” icon to restore all settings to the values last saved to or retrieved from ICA-101 series.

Network

Home | View Video | Administration | Exit

System | Network | Image | User | Status

IP Setting	<input type="radio"/> Obtain Address automatically (DHCP) <input checked="" type="radio"/> Fixed IP Address IP Address: <input type="text" value="192"/> <input type="text" value="168"/> <input type="text" value="0"/> <input type="text" value="20"/> Subnet Mask: <input type="text" value="255"/> <input type="text" value="255"/> <input type="text" value="255"/> <input type="text" value="0"/> Gateway: <input type="text"/> <input type="text"/> <input type="text"/> <input type="text"/> DNS Address: <input type="text"/> <input type="text"/> <input type="text"/> <input type="text"/>
Wireless Setting	Mode: <input type="text" value="Infrastructure"/> Authentication Type: <input type="text" value="Open System"/> ESSID: <input type="text" value="ANY"/> Domain: <input type="text" value="USA"/> Channel No: <input type="text" value="11"/> WEP Disabled <input type="button" value="Configure WEP"/>
DDNS	DDNS: <input type="radio"/> Enable <input checked="" type="radio"/> Disable Service Provider: <input type="text" value="www.dyndns.org"/> Host Name: <input type="text"/> Account: <input type="text"/> Password: <input type="text"/> Check WAN IP Schedule: <input type="text" value="Every 24 Hrs"/> starting at <input type="text" value="12"/> : <input type="text" value="00"/> <input type="text" value="pm"/>
Options	UPnP: <input type="checkbox"/> Enable UPnP Second Port: <input type="checkbox"/> Enable Second Port for HTTP connections Port Number: <input type="text" value="1024"/> (1024 ~ 65534) The standard HTTP port (80) is always enabled.

IP Setting:

There are two options to select from the IP setting.

M Note Access to ICA-101 series is done through assigning a proper IP address. Please make sure to use a vacant IP address when you assign the IP address for ICA-101 series. This will prevent errors from occurring if the IP address is overlapped.

Obtain Address Automatically (DHCP):

If your network already exists a DHCP server, you can select this option for ICA-101 series to get an IP address automatically.

Fixed IP Address:

You can select this option and directly enter the network settings.

The default settings are as follows:

- Default IP – 192.168.0.20
- Subnet Mask – 255.255.255.0

Wireless Setting: (ICA-101W only)

Mode:

Use this option to determine the type of wireless communication for ICA-101W. There are two choices of **Infrastructure**, and **Ad-hoc**. The default setting for the Connection Mode is Infrastructure.

Authentication Type:

Select appropriate authentication type, Open System or Shared Key, which matches with your current wireless network.

ESSID:

This field is used to setup which wireless network (ESSID: Extended Service Set ID) ICA-101W is to be connected for communication. The ESSID is a unique identifier shared among all points in a wireless network environment. The default ESSID is ANY, which will let ICA-101W connect to ANY access point under Infrastructure mode. To connect ICA-101W to a specific access point on the network, make sure to set ESSID of ICA-101W the same as the AP's ESSID for communication. Type any string up to 32 characters long (spaces, symbols, and punctuation are not allowed) in the ESSID box.

To connect ICA-101W to an Ad-hoc wireless workgroup make sure to set the same wireless channel and ESSID to match with the PC/Notebook wireless channel and ESSID for direct wireless communication under the Ad-hoc wireless workgroup.

Domain:

This option allows you to change the wireless domain of ICA-101W freely.

Channel No:

The pull down menu provides the wireless channel for communication. A "channel" is a range of frequencies to be used in communication between ICA-101W and Access Point in Infrastructure mode or ICA-101W and PC/Notebook in Ad-hoc mode. Select the appropriate channel from the drop-down list.

WEP:

The current WEP status is shown here. To configure WEP settings, please click "Configure WEP" button.

WEP Key Setting

WEP Encryption:

Passphrase:

Default Key	Key Value
<input checked="" type="radio"/> Key 1:	<input type="text" value="0000000000"/>
<input type="radio"/> Key 2:	<input type="text" value="0000000000"/>
<input type="radio"/> Key 3:	<input type="text" value="0000000000"/>
<input type="radio"/> Key 4:	<input type="text" value="0000000000"/>

WEP Key Setting:

WEP Encryption: Select the option used on your Wireless LAN.

None - This is the default setting. If selected, data is not encrypted before being transmitted.

64 Bit Keys - If selected, data is encrypted with the 64-bit default key you entered below.

128 Bit Keys - If selected, data is encrypted with the 128-bit default key you entered below.

Passphrase: Enter a phrase in this field, then click “Generate” button. ICA-101W will generate 4 key values automatically.

Default Key: Specify a key value as default WEP key.

Key Value: If WEP Encryption is enabled, you must enter at least one key value. All transmissions are encrypted with Default Key. Other wireless stations must use the same key value in the same position of their key table. (It does not have to be selected as the default key.)

The other key values are optional, and are used only for decrypting data. This allows you to use different keys for transmitting and receiving, if required.

When inputting a key value, follow these rules:

- For 64 Bit Encryption, keys must be 10 characters.
- For 128 Bit Encryption, keys must be 26 characters.

Keys must be entered in Hex characters, which are A ~ F, and 0 ~ 9

DDNS:

DDNS:

Enable or disable DDNS function.

Service Provider:

Choose a service provider from the list. ICA-101 series only supports DynDNS currently.

Host Name:

Enter the host name which DDNS service provider assigned to you.

Account:

Enter the login name for your DDNS account.

Password:

Enter the password for your DDNS account.

Check WAN IP schedule:

This option determines how often ICA-101 series checks the WAN IP status.

Options:

UPnP:

If UPnP is enabled, ICA-101 series will broadcast its availability using UPnP. UPnP compatible systems such as Windows XP will then be able to detect the presence of ICA-101 series.

Second Port:

This option allows you to open a second port for ICA-101 series. The HTTP connections (using your Web Browser) can use the port number you specified below instead of the standard HTTP port 80. The configurable port range is 1024–65534.

Apply/Cancel:

After making sure all settings in the System are correct, click on the “**Apply**” icon to store the settings for ICA-101 series. You can alternatively click on the “**Cancel**” icon to restore all settings to the values last saved to or retrieved from ICA-101 series.

Image

Video Settings	Resolution: <input type="text" value="320*240"/> Image Quality: <input type="text" value="Very High"/> Power line frequency: <input type="text" value="60Hz"/> (for fluorescent lighting)
Adjustment	Exposure: <input type="text" value="Automatic"/> Red: <input type="text" value="32"/> (0 ~ 64) Green: <input type="text" value="32"/> (0 ~ 64) Blue: <input type="text" value="32"/> (0 ~ 64) <input type="button" value="Defaults"/>
Options	Time Stamp: <input type="checkbox"/> Enable Text Overlay: <input type="checkbox"/> Enable Text: <input type="text"/> Audio: <input type="checkbox"/> Enable (requires microphone)

Video Settings:**Resolution:**

Select the desired video resolution format ranging from 160x120 and 320x240 (default).

Image Quality:

Select the desired image quality with five levels from very low to very high. Lower image quality will generate more compact file size and use less bandwidth; vice-versa.

Power line frequency:

Please check your local electricity frequency and select proper value for ICA-101.

Adjustment:**Exposure:**

Select Automatic or Manual as required.

If manual exposure is selected, an exposure value option will appear in the right. The default value is 32.

Red/Green/Blue:

Adjust the respective color settings with default setting at 32.

Defaults:

Click "Defaults" button to restore Exposure and Red/Green/Blue values back to default.

Options:**Time Stamp:**

Enable this option, the current time can be shown on the video image.

Text Overlay:

Enable this option, and enter the text contents in the right. The string you entered will appear on the upper right of video image.

Audio:

Enable Audio function by selecting this option. Please note that this function requires an external microphone attached to the MIC IN port of ICA-101 series.

Apply/Cancel:

After making sure all settings in the Image are correct, click on the “Save” icon to store the settings for ICA-101 series. You can alternatively click on the “Cancel” icon to restore all settings to the values last saved to or retrieved from ICA-101 series.

User

Home | View Video | Administration | Exit

System | Network | Image | User | Status

Admin Login	Administrator ID: <input type="text" value="admin"/> Password: <input type="password" value="*****"/> Verify Password: <input type="password" value="*****"/>
User Access	Allow access by: <input checked="" type="radio"/> Everyone <input type="radio"/> Only users in database
User Database	<div style="border: 1px solid gray; height: 100px; width: 100%;"></div> <p style="text-align: center;"> <input type="button" value="Add"/> <input type="button" value="Modify"/> <input type="button" value="Delete"/> </p>
Alerts	E-mail Alert: <input type="checkbox"/> Send E-Mail Alert when Motion Detected Send to: <input type="text"/> Show "From" as: <input type="text"/> Subject: <input type="text"/> Outgoing Mail SMTP Server: <input type="text"/> <input type="checkbox"/> My Mail Server Requires Authentication Account Name: <input type="text"/> Password: <input type="password"/>

Admin Login:

These fields are used for entering the Administrator ID along with the password to access the Administration settings. Be sure to enter the password twice to confirm the details, once in the Password field and again in the Verify Password field. The default settings for Administrator ID and Password are both admin.

User Access:

You can set the access privileges for users here. The default setting is “Allow access by everyone”. The alternative option is “Allow access by only users in database”. If you

use this option, you have to add users in the database below.

Alerts:

Select “Send E-mail Alert when Motion Detected” and enter the relevant information such as Receiver e-mail Address, Sender e-mail Address, Subject of the mail, SMTP server address, and authentication information if needed.

M Note	Motion Detection can be activated by rapid changes of light, as well as by moving object. For this reason, it should be used indoor and the light is fairly constant.
-------------------	---

Send to:

Enter the receiver e-mail address in the field.

Show “From” as:

Enter the sender e-mail address in the field. This field must be entered with a valid e-mail format.

Subject:

Enter the subject of outgoing mail.

Outgoing Mail SMTP Server:

Enter the address of SMTP server used to send the mail. Please ensure the server is using SMTP protocol and able to relay mails for you. Some SMTP server may require authentication. You can select “My Mail Server Requires Authentication”, and enter the Account Name and Password fields below for authentication.

Status

The Status screen displays the detailed information of ICA-101 series, including Device Name, Description, MAC Address, IP Address, Network Mask, Gateway IP, F/W version, and Current Viewers.

Status	Device Name:	SC000000	
	Description:		
	MAC Address:	00:30:4f:00:00:00	
	IP Address:	192.168.0.20	
	Network Mask:	255.255.255.0	
	Gateway:		
	FW version:	V1.01	<input type="button" value="Upgrade Firmware"/>
	Current Viewers:	0	
Log	System Log:	<div style="border: 1px solid black; padding: 5px;">01/01/2000 01:59:55 Lan is activated</div>	

Upgrade Firmware:

Click “Upgrade Firmware” button, a dialog box appears. Use “Browse” button to locate the upgrade file in your computer, then click “Start Upgrade” to start the upgrading.

M**Note**

Do not interrupt the upgrading procedure during proceeding; or the inner component might be permanently damaged.

System Log:

ICA-101 series will record the system events here. You can use these logs for diagnosis.

Refresh:

Click “Refresh” button to renew the system log.

Restart:

Click “Restart” button to reboot your camera.

Restore Factory Defaults:

Click “Restore Factory Defaults” button to load default settings to camera.

Chapter 5

Client Utility

5

Install Procedure

STEP 1

Insert the CD-ROM into the CD-ROM drive to initiate the autorun program. Once completed a menu screen will appear as follows:

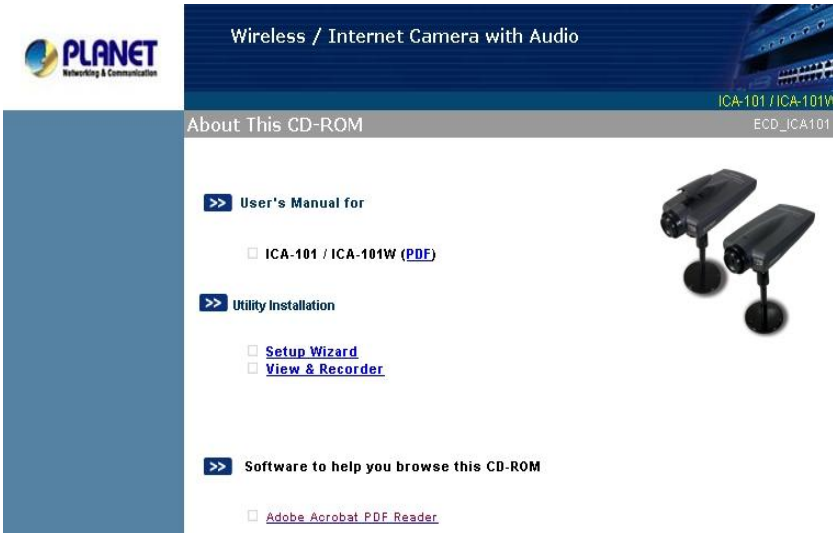

STEP 2

To install the Viewer & Recorder Application click on the "**Viewer & Recorder**" hyperlink to activate the installation procedure for the application program.

If the above screen is not shown, you can start the installation as follows.

1. Click on **Start Menu/ Run**.
2. Enter "D:\Utility\setup.exe" in the appeared box, where "D" is the letter of your CD-ROM drive.
3. Click on "**OK**" button.

STEP 3

The Welcome screen will appear. Click on the "**Next**" button to proceed with the installation.



STEP 4

A “Choose Destination Location” screen appears, you may click on “**Next**” to accept the recommended destination location or click on “**Browse**” to select another location. After specifying the desired destination location, click on “**Next**” to proceed further.

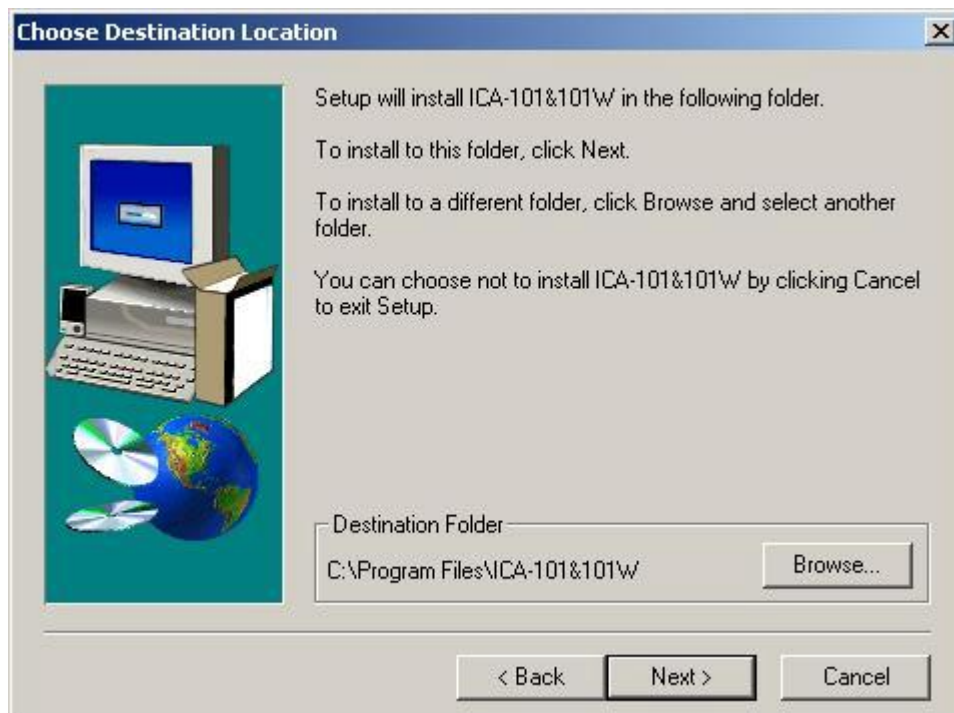

STEP 5

The Select Program Folder prompt will appear providing information of where the application will be located, click on “**Next**” to continue. Click on “**Back**” can return to the previous screens.



STEP 6

A message box appears to inform you that an ActiveX plug-in has been installed to your computer..

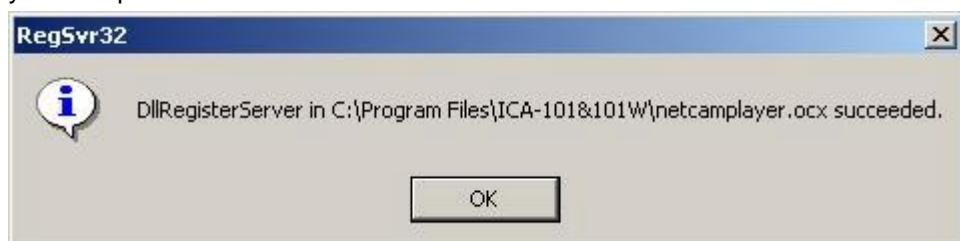

STEP 7

Once the setup is complete, the following message box pops up. Click "OK" button to close the screen.

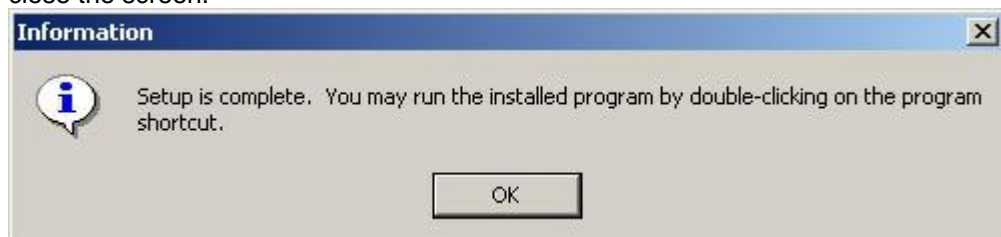

Using Viewer & Recorder Utility



After successfully installing the utility, this icon, , will be added to the desktop. Double click on it to launch the program.

Once the utility is executed, its main screen appears as follow.

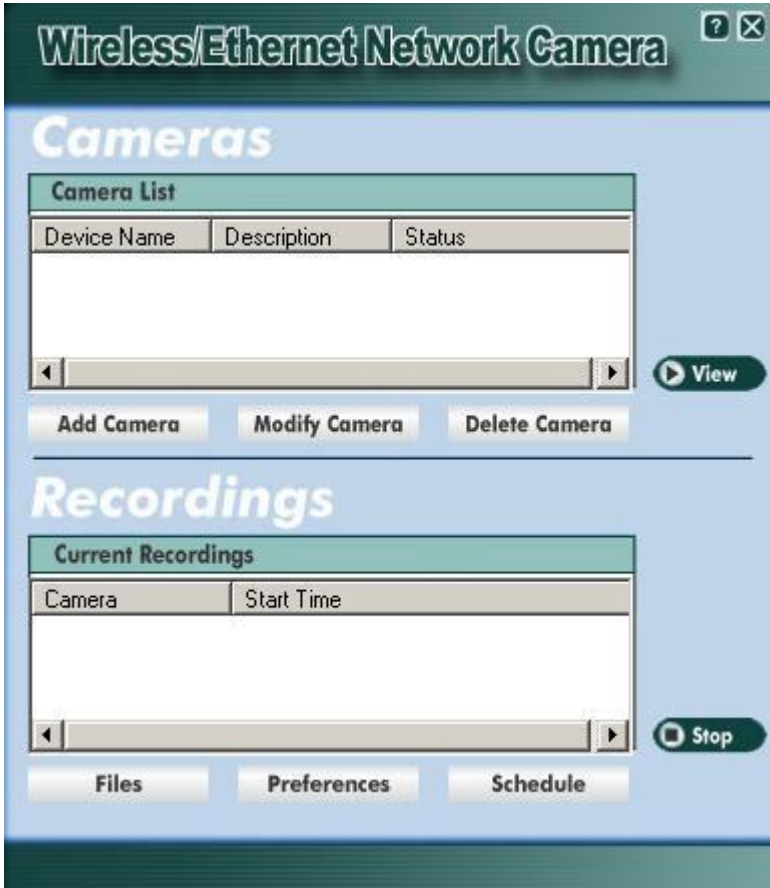

The Camera List displays all available ICA-101 series you have defined.

The Current Recordings lists scheduled recording activity in progress.

Add Camera

Click "Add Camera" button, the utility will search available cameras in LAN automatically. Once it finds the camera, the detailed information will be displayed. If the camera has enabled User Access control, you have to enter the authorized Name and Password in Login field. Then click "Add" button, the camera will be added to the Camera List immediately.

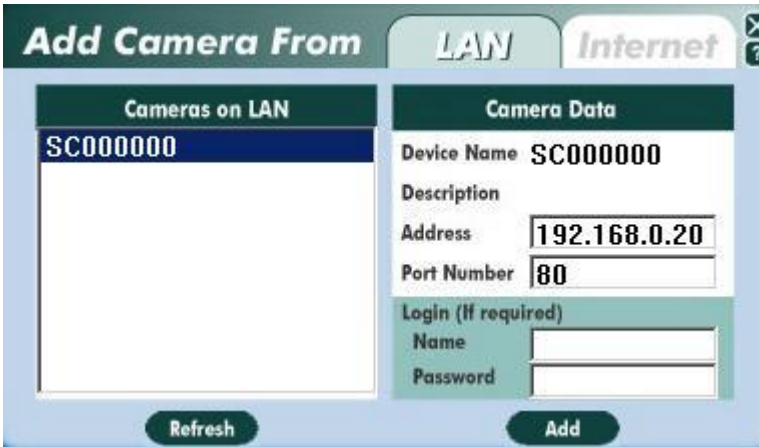

If you want to add a camera which located on Internet, click "Internet" tab and fill in the necessary information: IP address, port number, and login name/password (if required). Click "Test" button to check the connection to the camera, and click "Add" to add the camera to Camera List.

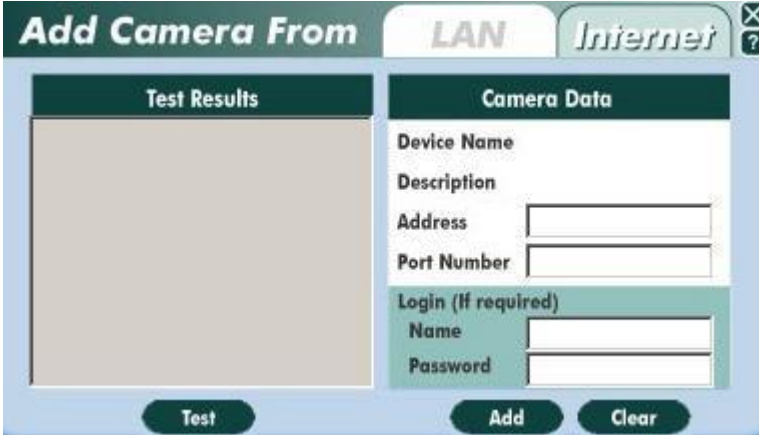

Modify Camera



If a camera's IP address or port number has been changed, you can use this option to rebuild the connection. Select an existing camera from Camera List, click "Modify Camera" button. After modifying, you can click "Test" button to check the connection. Click "Save" to save the changes.



Delete Camera

Select an existing camera from Camera List, click “Delete Camera” button to remove it from the list.

View

To view live video with utility, select an existing camera from Camera List, then click “View” button. The live video of the selected camera will pop up immediately. There are three control buttons available in this screen.  is for play,  is for recording, and  is for stop.



Files

Click “Files” button to check the files which have been recorded in your computer. Select a file and click “Play”, your computer will use Media Player program to play the file. Select a file and click “Delete” to delete it. Click “Explore” button to open the folder which stores these video files.



Preferences

To set recording preferences, click “Preferences” button. You can modify File Location and Time Limit here. The Time Limit sets the maximum time period of a recording session which started by clicking button on the View screen.



Schedule

To schedule a recording session, click “Schedule” button. The screen displays all scheduled recordings.



Click “Add” button, and select desired parameters, then click “Save” button. The new schedule will be added to the list immediately. To modify an existing schedule, select the schedule and click “Modify”. Change the parameters to desired values, then click “Save”. To delete an existing schedule, select the schedule and click “Delete” button. The record will be removed from list right away.

Appendix A

Frequently Asked Questions



Internet Camera Features
Q: What is an Internet Camera?
A: The Internet Camera is a standalone system connecting directly to an Ethernet or Fast Ethernet network. And ICA-101W also supports the wireless transmission based on the IEEE 802.11b standard. It is different from the conventional PC Camera, the Internet Camera is an all-in-one system with built-in CPU and web-based solutions providing a low cost solution that can transmit high quality video images for monitoring. The Internet Camera can be managed remotely, accessed and controlled from any PC/Notebook over the Intranet or Internet via a web browser.
Q: What algorithm is used to compress the digital image?
A: ICA-101 series utilizes the MPEG-4 image compression technology providing high quality images for users. The high compression capabilities of MPEG-4 reduce network bandwidth requirements to amazingly low levels.
Q: What is the wireless transmission range for ICA-101W?
A: Generally the wireless distance can go up to 100 meters indoors and up to 300 meters outdoors. The range is limited by the number of walls, ceilings, or other objects that the wireless signals must pass through. Typical ranges vary depends on the types of materials and background Radio Frequency (RF) noise in your home or business and the configuration setting of your network environment.
Internet Camera Installation
Q: Can ICA-101 series be used outdoors?
A: ICA-101 series is not weatherproof. It needs to be equipped with a weatherproof case to be used outdoors, and it is not recommended.
Q: What network cabling is required for ICA-101 series?
A: ICA101 series uses Category 5 UTP cable allowing 10 Base-T and 100 Base-T networking.
Q: Can ICA-101 series be setup as a PC-cam on the computer?
A: No, ICA-101 series can be used only on Ethernet and Fast Ethernet network.
Q: Can ICA-101 series be connected on the network if it consists of only private IP addresses?
A: Yes, ICA-101 series can be connected to LAN with private IP addresses.
Q: Can ICA-101 series be installed and work if a firewall exists on the network?
A: Yes, you can use Second Port function to allow the traffic from Internet passing through firewall and access your ICA-101 series..

Appendix B

Trouble Shooting



Q: I cannot access the Internet Camera from a web browser.

A: If ICA-101 series do not respond, check the following:

- Machine is properly installed, LAN or WLAN connection is OK, and it is powered ON. You can test the connection by using the "Ping" command:
Open the MS-DOS window or command prompt window.
Enter the command:
ping 192.168.0.20
If no response is received, either the connection is not working, or your PC's IP address is not compatible with ICA-101 series' IP Addresses. (See next item.)
- Ensure that your PC is using an IP Address within the range 192.168.0.1 to 192.168.0.254 (excluding 192.168.0.20). Also, the Network Mask should be set to 255.255.255.0 to match ICA-101 series. In Windows, you can check these settings by using *Control Panel-Network* to check the *Properties* for the TCP/IP protocol.

Q: The Viewer & Recorder utility does not list my ICA-101 series.

A: Please check the following:

- ICA-101 series is installed, LAN connections are OK, it is powered ON and startup is complete.
- Ensure that your PC and the Wireless/Ethernet Network Camera are on the same network segment. (If you don't have a router, this must be the case.)
- Ensure that your PC has the TCP/IP network protocol loaded. In Windows, this is done by using Control Panel-Network. If an entry for TCP/IP -> Network card is not listed, use Add - Protocol - Microsoft - TCP/IP to add it. You then need to select the new entry (TCP/IP -> Network card), click Properties, and configure the IP Address tab.
- If your LAN has a DHCP Server, you can select "Obtain an IP Address automatically".
- Otherwise, you must select "Specify an IP Address", and enter values for IP Address, Subnet Mask, and Gateway. All devices on your LAN must use compatible values. Remember that each device needs a unique IP Address, and the same Subnet Mask.

Q: Why does the Internet Camera work locally but not externally?

A1: Might be caused from the firewall protection. Need to check the Internet firewall with your system administrator.

A2: The default router setting might be a possible reason. Need to double check if the configuration of the default router settings is required.

Q: Why do a series of broad vertical white lines appear through out the image?

A: A likely issue is that the CMOS sensor becomes overloaded when the light source is too bright such as direct exposure to sunlight or halogen light. You need to reposition the Internet Camera into a more shaded area immediately for the bright light will damage the CMOS sensor.

Q: There is bad focus on ICA-101 series, what should be done?

A: The focus might not be correctly adjusted for the line of sight. You need to adjust the focus manually by rotating the lens clockwise or counterclockwise..

Q: Noisy images occur. How can I solve the problem?

A1: The video images might be noisy if ICA-101 series is used in a very low light environment. To solve this issue you need more light.

Q: There is a poor image quality, how can I improve the image?

A1: A possible cause might be the incorrect display properties configuration for your desktop. You need to open the Display Properties on your desktop and configure your display to show at least 65'000 colors, for example at least 16-bit.

M
Note

Applying only 16 or 256 colors on your computer will produce dithering artifacts in the image.

A2: The configuration on ICA-101 series image display is incorrect. You need to adjust the image related parameter to improve images such as exposure, and colors. Please refer to the Image section of Chapter 4 for detail information.

Q: There are no images available through the web browser?

A: The ActiveX might be disabled. If you are viewing the images from Internet Explorer make sure ActiveX has been enabled in the Internet Options menu. Alternatively, you can use the Viewer & Recorder utility for viewing the required images.

Appendix C

Specification



Model	ICA-101	ICA-101W
Hardware Specifications		
10/100M Ethernet port	1	
Wireless LAN	None	Built-in 802.11b wireless LAN module
IP assignment	Manually assigned, DHCP	
WEP encryption	None	64-bit, 128-bit
LED indicator	PWR, ACT, LAN	PWR, ACT, LAN, WLAN
Power requirement	DC 5V, 2A	
Audio support	Yes	
Dimension	164 x 88 x 53 mm	
Operating temperature	0 ~ 40 degree C	
Storage temperature	-10 ~ 70 degree C	
Humidity	5% ~ 95% non-condensing	
Video Specifications		
Image sensor	CMOS, 1/4 inch, VGA resolution	
Lens	Fixed focus	
Resolution	160 x 120, 320 x 240	
Focus extension	70cm - ∞	
Compression	MPEG-4	
Management / Features		
Management	Web interface, Utility	
Additional Features	Image recording, NTP Support, Email auto send; System event log, Web or Utility firmware upgrade, Motion detection, DDNS, UPnP, Open second port, Time stamp, Real-time monitoring	